

Mobrey™ Hydrastep

Water/Steam Monitoring System



- Electronic gauging system for steam drum level measurement
- Fault tolerant and fail safe design
- Electrodes available for up to 1040 °F (560 °C) and 4350 PSI (300 Bar) with a choice of insulators
- High clarity local and remote displays
- 4–20 mA output proportional to water/steam interface level
- Relay outputs for level alarms and high or low level trips
- ASME approved design and 'Sole gauge' compliant with international approvals

Hydrastep 2468 Electronic Gauging System



Hydrastep Control Unit

The Hydrastep system consists of a water column fitted with up to 32 electrodes, an electronic control unit, local and remote displays, and connecting cables.

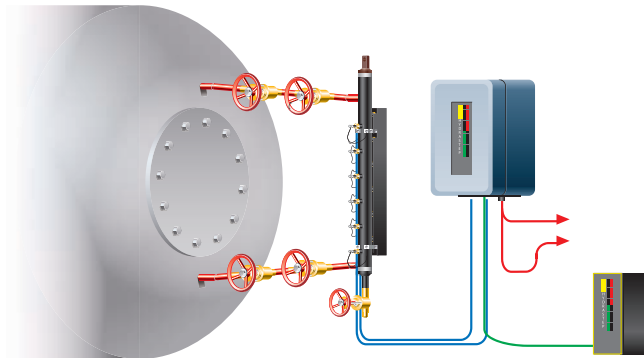

Failure to detect low water levels in steam-raising plant can have costly and potentially disastrous consequences. Reliable water level detection is vital to prevent damage to plant and personnel.

The Hydrastep electronic gauging system is the ideal ‘fit and forget’ solution to overcome the problems associated with unreliable and maintenance-intensive gauge glasses.

Designed for totally reliable operation, Hydrastep is both fail-safe and fault tolerant.

Modern boilers are designed to provide clean, dry steam. Detection of incorrect water level in the drum is essential:

- Too high a level can give wet steam, leading to turbine blade erosion, and
- If the level is too low, the boiler tubes can overheat, with the danger of explosion.

All national legislatures require indication of water level in steam generating plant and drum level indication in the control room is absolutely necessary. Conversely however, false alarms leading to plant shutdown and loss of revenue are also highly undesirable.

Hydrastep offers exceptional levels of security. All measurements are interpreted as water, steam or contamination. Both short and open circuit conditions are detected and indicated as faults.

An independent report by Factory Mutual Research concluded that the probability of Hydrastep missing a trip condition is less than 1 in 300 million and that nuisance trips will be less than 1 in 10 million. Hydrastep combines optimum safety indication with virtually no risk of false alarms.

For information on Emerson's Mobrey Hydrastep for steam/water detection, please refer to data sheet BP2462.

Contents

Hydrastep Ordering Information	page 3	Dimensional Drawings	page 8
Specifications	page 6		

Hydrastep Ordering Information

A Hydrastep electronic steam/water gauging system comprises:-

- Control unit (see Table 1 on page 3)
- Electrodes (see Table 2 on page 4)
- Water column (see Table 4 on page 4)
- Electrode cables (see Table 5 on page 5)
- Remote display (optional, see Table 6 on page 5)
- Anti seize compound (see Table 3 on page 4)

Specification and selection of product materials, options, or components must be made by the purchaser of the equipment. See page 6 for more information on Material Selection.

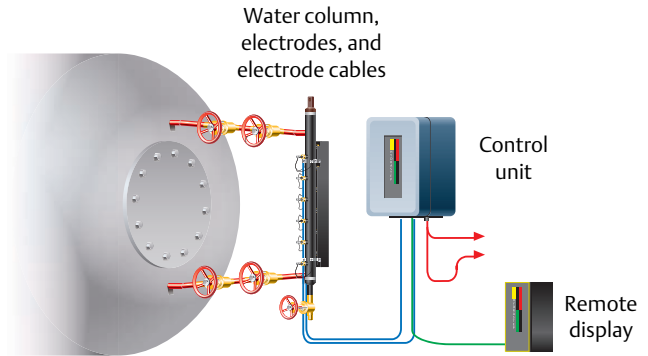

Table 1. Hydrastep Control Unit Ordering Information

Model	Product Description
2468	Hydrastep Control Unit
Power Supply Input Boards	
CA	16 point EGS (Electronic Gauging System), single input board and power supply (ac mains)
CB	32 point EGS, dual input board and power supplies (2 x ac mains)
CC	16 point EGS, single input board and power supply (24 Vdc)
CD	32 point EGS, dual input board and power supplies (2 x 24 Vdc)
CE	32 point EGS, dual input board and power supplies (1 x ac, 1 x dc)
Optional Output Boards	
AD	No output boards
BD	1 Relay output board (4 relays)
CD ⁽¹⁾	2 Relay output boards (8 relays)
DD	4 Relay output boards (16 relays)
ED	1 Relay output board with time delay (4 relays)
FD	2 Relay output boards with time delay (8 relays)
GD	4 Relay output boards with time delay (16 relays)
Typical Model Number: 2468 CB CD	

1. For dual input board systems, a minimum of two relay output boards are required.

Table 2. Hydrastep Electrodes Ordering Information

Model	Product Description	Max Pressure PSI (Bar)	Max Temp. °F (°C)	ph Range
459600602 ⁽¹⁾	Low pressure threaded Electrode. Zirconia insulator	1740 (120)	698 (370)	7 to 11
459600802 ⁽¹⁾	Low pressure threaded Electrode. PTFE insulator	725 (50)	500 (260)	7 to 13.5
246781ZA ⁽¹⁾	High pressure series III Electrode. Swagelok style union with Zirconia insulator. 3/4-in. thread	3045 (210)	698 (370)	7 to 11
246785A ⁽¹⁾	Super Critical series III Electrode. Swagelok style union with ZTA insulator. 7/8-in. thread	4350 (300)	1040 (560)	7 to 11

1. Do not mix electrode types in the same water column.

Table 3. Hydrastep Anti Seize Compound Ordering Information

Model	Product Description
830007220	Electrode Thread Lubricant (1 fl oz)

Table 4. Hydrastep Water Column Ordering Information

Model	Product Description
120 ⁽¹⁾	Low pressure (up to 1740 psi / 120 bar) water column (schedule 80 process connections) – see Table 7 on page 7
210 ⁽¹⁾	High pressure (up to 3045 psi / 210 bar) water column (schedule 160 process connections) – see Table 7 on page 7
300 ⁽¹⁾⁽²⁾	Super critical (up to 4350 psi / 300 bar) water column (schedule XXS process connections) – see Table 7 on page 7
In-line Design	
L ⁽³⁾	In-line design (top-and-bottom process connections)
No Code ⁽³⁾⁽⁴⁾	Side-arm design (side-and-side process connections with hanger)
Distance Between Top and Bottom Tappings	
TTTT ⁽⁵⁾	TTTT = Distance between top and bottom tappings (mm or inches)
Site Range	
SSSS ⁽⁶⁾	SSSS = Distance between top and bottom electrodes (mm or inches)
Number Of Electrodes	
XX	Number of electrode ports – specify an even number ranging from 08 up to a maximum of 32)
Typical Model Numbers: 120-1250-900-24 (Low Pressure Water Column, Side-and-side, 1250 mm Process Connection Centers) 210L-43-37-16 (High Pressure Water Column, Top-and-bottom, 37 in. Process Connection Centers)	

- See [Table 7 on page 7](#) for details of the water column.
- Available to special order only.
- Specify the process connection size (25, 32, 38, or 50 mm) on the column design sheet, which is available from your local sales office.
- Water column with hanger design has side arm/side-and-side process connections. Specify the drain connection size (20 or 25 mm) on the column design sheet, which is available from your local sales office.

- 5. Maximum tap-to-tap distance is 138 in. (3500 mm).
- 6. Refer to water column design sheet available from your local sales office.

Table 5. Hydrastep Electrode Cables Ordering Information

Model	Product Description
24680204A ⁽¹⁾	10 ft. (3m) multi-core electrode cable (for up to 8 electrodes)
24680205A ⁽¹⁾	33 ft. (10 m) multi-core electrode cable (for up to 8 electrodes)
24680206A ⁽¹⁾	60 ft. (18 m) multi-core electrode cable (for up to 8 electrodes)
24680207A ⁽¹⁾	98 ft. (30 m) multi-core electrode cable (for up to 8 electrodes)

- 1. Select two cables if there are 8 to 16 electrodes in the column or select four cables if there 18 to 32 electrodes in the column.

Table 6. Hydrastep Accessories Ordering Information

Model	Product Description
24683C	32 point remote display, large panel mount
24683D	32 point remote display, IP65 wall mount (Type NEMA [®] 4)
24683BB	32 point remote display, DIN panel mount

Figure 1. Hydrastep Remote Displays

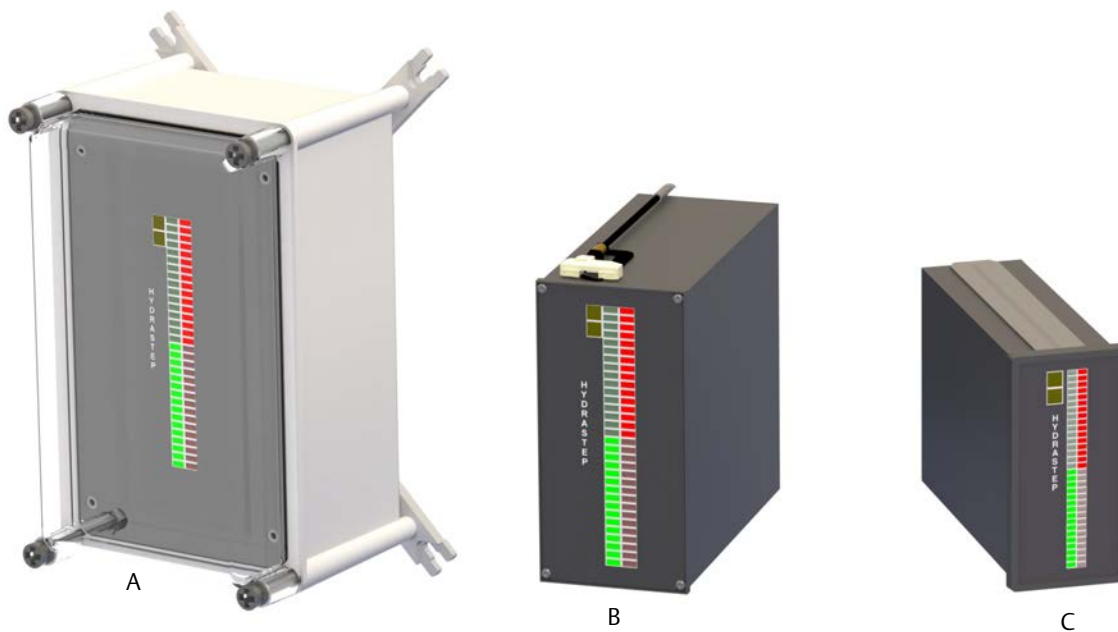

- A. Mobrey wall mount IP65 remote display (24683D)
- B. Mobrey large panel mount display (24683C)
- C. Mobrey DIN panel mount remote display (24683BB)

See [page 9](#) for dimensional drawings.

Specifications

Material selection

Emerson™ provides a variety of products with various product options and configurations including materials of construction that can be expected to perform well in a wide range of applications. The product information presented is intended as a guide for the purchaser to make an appropriate selection for the application. It is the purchaser’s sole responsibility to make a careful analysis of all process parameters (such as all chemical components, temperature, pressure, flow rate, abrasives, contaminants, etc.), when specifying product, materials, options and components for the particular application. Emerson is not in a position to evaluate or guarantee the compatibility of the process fluid or other process parameters with the product, options, configuration or materials of construction selected.

Hydrastep specifications

General						
Product	Hydrastep electronic steam/water gauging system					
Electrode Channels	8 to 32, in pairs. See Table 2 on page 4 for Hydrastep electrode specifications					
Water/Steam Threshold	Default 0.6 μS/cm in clean water. Configurable 1.6 μS/cm					
Water conductivity	Up to 104 μS/cm. Models for higher conductivities up to 1600 μS/cm available to special order					
Display and fault indication						
Integral Display	Red/green bar graph, 32 LED segments. Display blanking from the bottom with less than 32 electrodes in use. Channel fault indication by flashing display segment. General fault indication by amber LED					
Remote Display	Indication same as Integral Display					
	Powered from main unit (1 display only). Local power 20 to 54 Vdc, 240 mA required for additional remote displays					
Electrical						
Power Supply ⁽¹⁾	Power supply (ac): 94 to 130V or 187 to 256V, 48Hz to 65Hz, 60VA max. Power supply (dc): 20 to 40V negative ground or isolated, 60W max.					
Analog Output	Signal is proportional to the water level Range: 0–20 mA or 4–20 mA, forward or reverse Accuracy: ± 0.2 mA Drive capability 600 ohms at nominal supply voltage, or 500 ohms at minimum supply voltage					
Relay Outputs (Optional)	Maximum of four relay boards can be fitted for alarm indication					
	<table border="0"> <tr> <td>Relay Board: Four independent change-over relays Relay contact rating (ac powered): <i>Maximum voltage of 250 Vac</i> <i>Maximum current of 8A</i> <i>Maximum switching power: 1500 VA</i></td> <td>Delayed Relay Board <i>(Specification as per Relay Board)</i> Delay range: 0 to 25s ± 1s</td> </tr> <tr> <td>Relay contact rating (dc powered): <i>Maximum voltage of 125 Vdc</i> <i>Maximum switching power:</i> <i>240W < 30V, 8A (resistive), 25W < 125V</i> <i>Minimum switching capacity 10mA @ 5 Vdc</i></td> <td></td> </tr> <tr> <td colspan="2">Type N safety: <i>Maximum current 100mA</i></td> </tr> </table>	Relay Board: Four independent change-over relays Relay contact rating (ac powered): <i>Maximum voltage of 250 Vac</i> <i>Maximum current of 8A</i> <i>Maximum switching power: 1500 VA</i>	Delayed Relay Board <i>(Specification as per Relay Board)</i> Delay range: 0 to 25s ± 1s	Relay contact rating (dc powered): <i>Maximum voltage of 125 Vdc</i> <i>Maximum switching power:</i> <i>240W < 30V, 8A (resistive), 25W < 125V</i> <i>Minimum switching capacity 10mA @ 5 Vdc</i>		Type N safety: <i>Maximum current 100mA</i>
Relay Board: Four independent change-over relays Relay contact rating (ac powered): <i>Maximum voltage of 250 Vac</i> <i>Maximum current of 8A</i> <i>Maximum switching power: 1500 VA</i>	Delayed Relay Board <i>(Specification as per Relay Board)</i> Delay range: 0 to 25s ± 1s					
Relay contact rating (dc powered): <i>Maximum voltage of 125 Vdc</i> <i>Maximum switching power:</i> <i>240W < 30V, 8A (resistive), 25W < 125V</i> <i>Minimum switching capacity 10mA @ 5 Vdc</i>						
Type N safety: <i>Maximum current 100mA</i>						
Remote Display Output	Drive to remote displays (maximum 6 units). 3280 ft. (1000 m) maximum distance					
Opto-isolated Fault Output	Detects fault in electrode connection (open circuit and short-circuit to ground)					
Environment						
Operating Temperature	-4 to 149 °F and -20 to 65 °C					
Operating Pressure	See Table 7 on page 7 for the Hydrastep water column specifications					
Relative Humidity	Up to 100%					

Mechanical	
Weight	26.4 lb (12 kg)
Control Unit Enclosure	Stainless steel 304, wall mounting (four point), IP65 / NEMA4X 16.7 in. high x 12.8 in. wide x 6.4 in. deep (425 mm x 325 mm x 163 mm)
Remote Display Unit Enclosure	24683BB (Case style: DIN Panel Mount) 24683C (Case style: Large Panel Mount) 24683D (Case style: IP65 Wall Mount)
Approvals	
ATEX	II 3G Ex nA IIC T4 Gc X (-20 °C ≤ Ta ≤ 65 °C)
CSA	(Canada) Ex nA [nL] nL IIC T4, (USA) Class 1 Zone 2, AEx nA IIC with relay output connected only to energy limited circuits
FM	Approved for boiler water-level control
LVD	EN 61010-1
Pressure Equipment Directive	Safety accessory
Electromagnetic Compatibility	EN 61326-1

1. Dual power supply version of Hydrastep Control Unit – [Table 1 on page 3](#) for option codes.

Table 7. Water Column Specifications

Parameter	LP Rectangular Section	HP Series 3	HP Super 3
Design Pressure	1740 psi (120 bar)	3045 psi (210 bar)	4350 psi (300 bar)
Test Pressure	2610 psi (180 bar)	4567 psi (315 bar)	6525 psi (450 bar)
Design Temp.	650 °F (343 °C)	698 °F (370 °C)	1040 °F (560 °C)
Design Code ⁽¹⁾	ASME B31.1 Power Piping	ASME B31.1 Power Piping	ASME B31.1 Power Piping
Maximum Length	138 in. (3500 mm)	138 in. (3500 mm)	138 in. (3500 mm)
Materials of Construction ⁽²⁾	Carbon Steel ASTM A105/A106 GR B	Carbon Steel ASTM A105/A106 GR B body with SA 479 – 316N electrode mounts	Stainless steel ASTM A312/A182 F316 with SA 479 – 316N electrode mounts
Protective Covers	18 SWG (17 AWG) Stainless steel	18 SWG (17 AWG) Stainless steel	18 SWG (17 AWG) Stainless steel
Gross Weight ⁽³⁾	26.5 lb (12 kg)	37.5 lb (17 kg)	37.5 lb (17 kg)
Electrode Types	459600602 or 459600802	246781ZA	246785A
Blanking Plugs ⁽⁴⁾	24569A	450600880	24673763A

1. Manufactured and tested in accordance with ASME Boiler and Pressure Vessel Code: Section 1.
2. Material certification: in accordance with BS EN10204 3.1 (we can also provide to BS EN10204 3.2 at additional cost and if specified by Customer, prior to order).
3. Typical for (610 mm / 24 in.) steam/water range, 12 port, with electrodes and covers.
4. Electrode port blanking plugs are available to order using the part numbers given in each column.

Dimensional Drawings

Figure 2. Hydrastep Enclosure

Dimensions are in inches (mm).

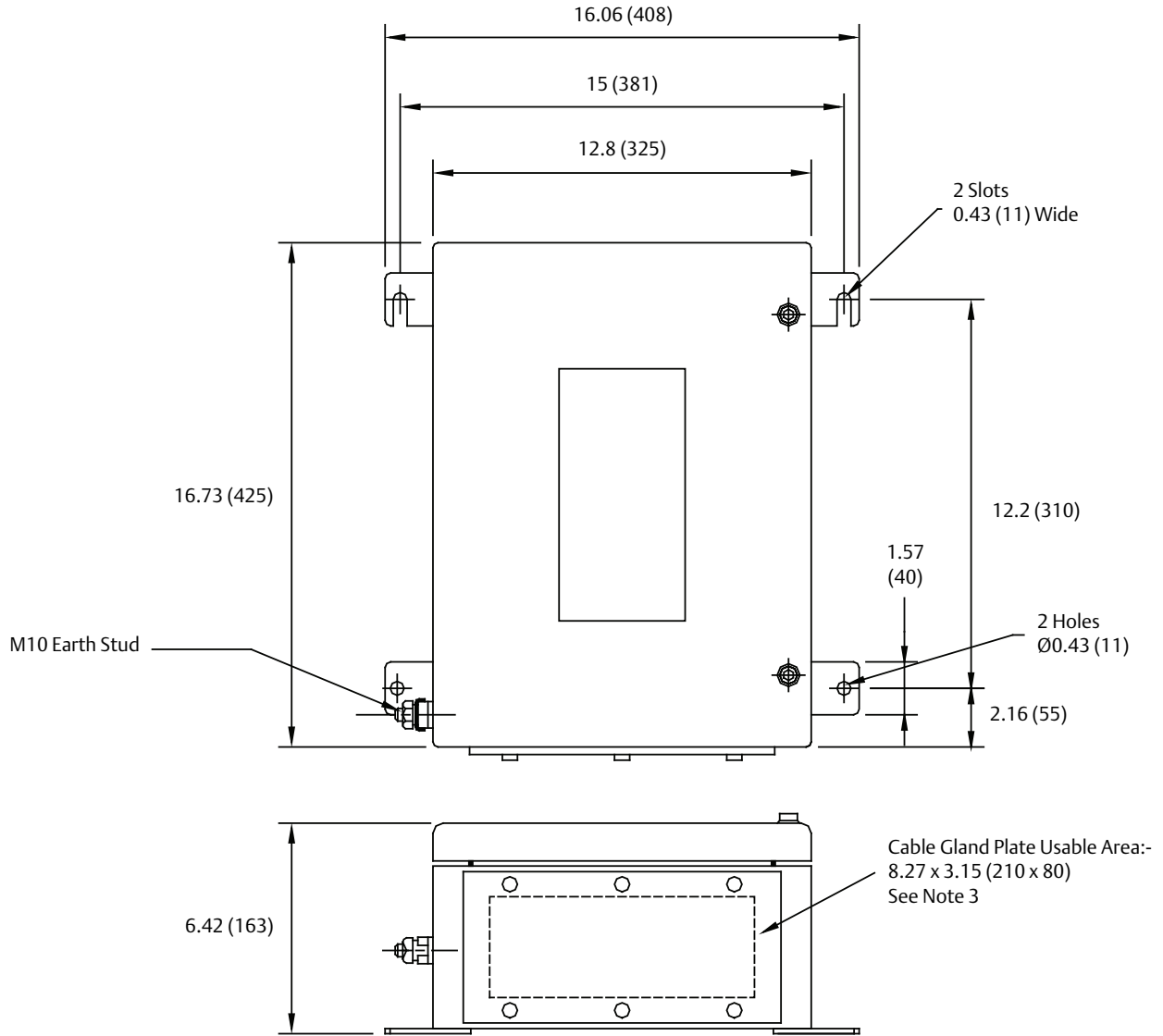

NOTES:

1. Weight: 12 kg
2. IP Rating: IP65 / NEMA4X
3. Material Thickness Between Cable Gland Holes Must Be 9 mm Minimum.
4. 'Enclosure: Stainless steel

Figure 3. Hydrastep DIN Panel Mount Remote Display (24683BB)

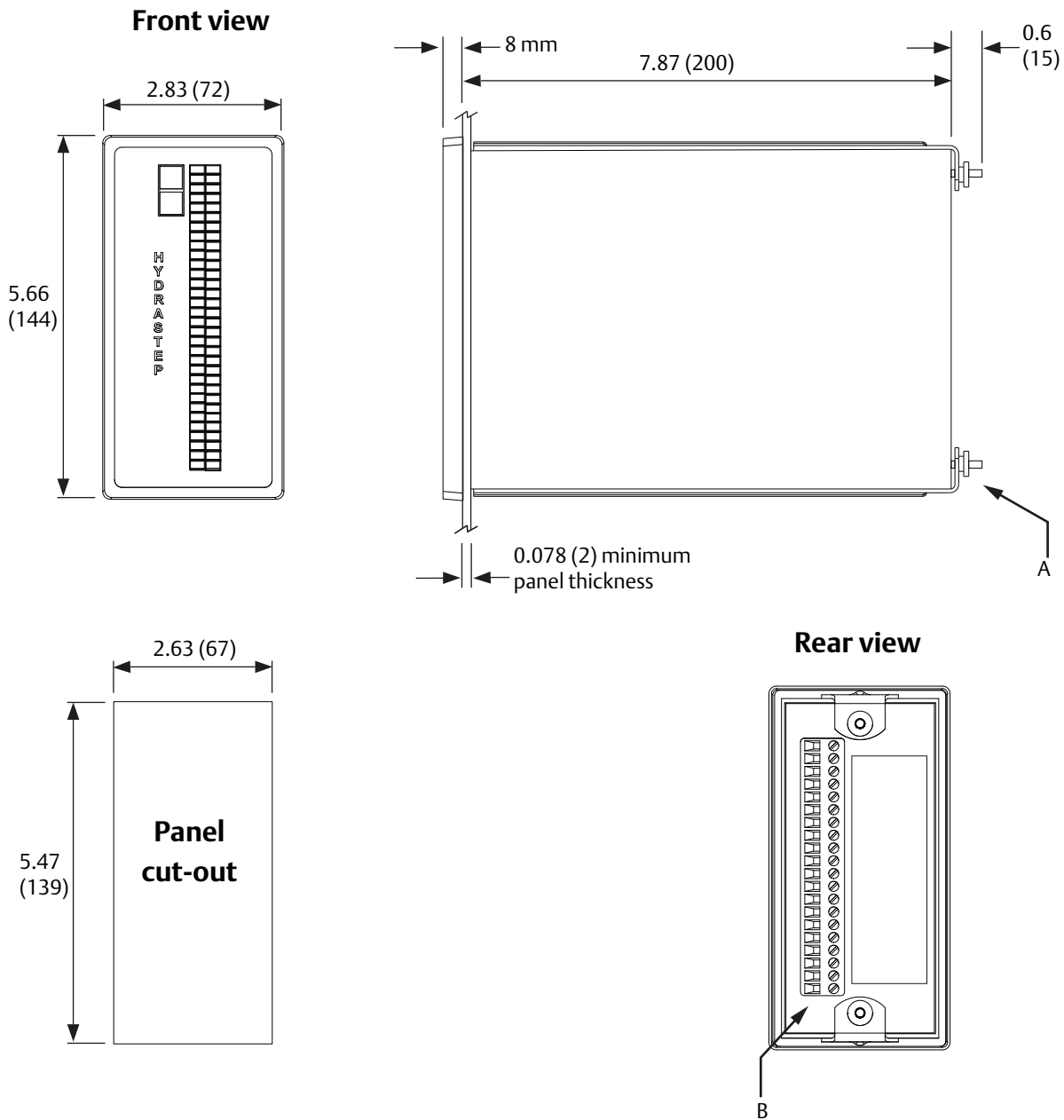

- A. Panel retaining clamps (two positions)
- B. Input terminals

Dimensions are in inches (mm). Allow space at the rear for cabling.

Figure 4. Hydrastep Large Panel Mount Remote Display (24683C)

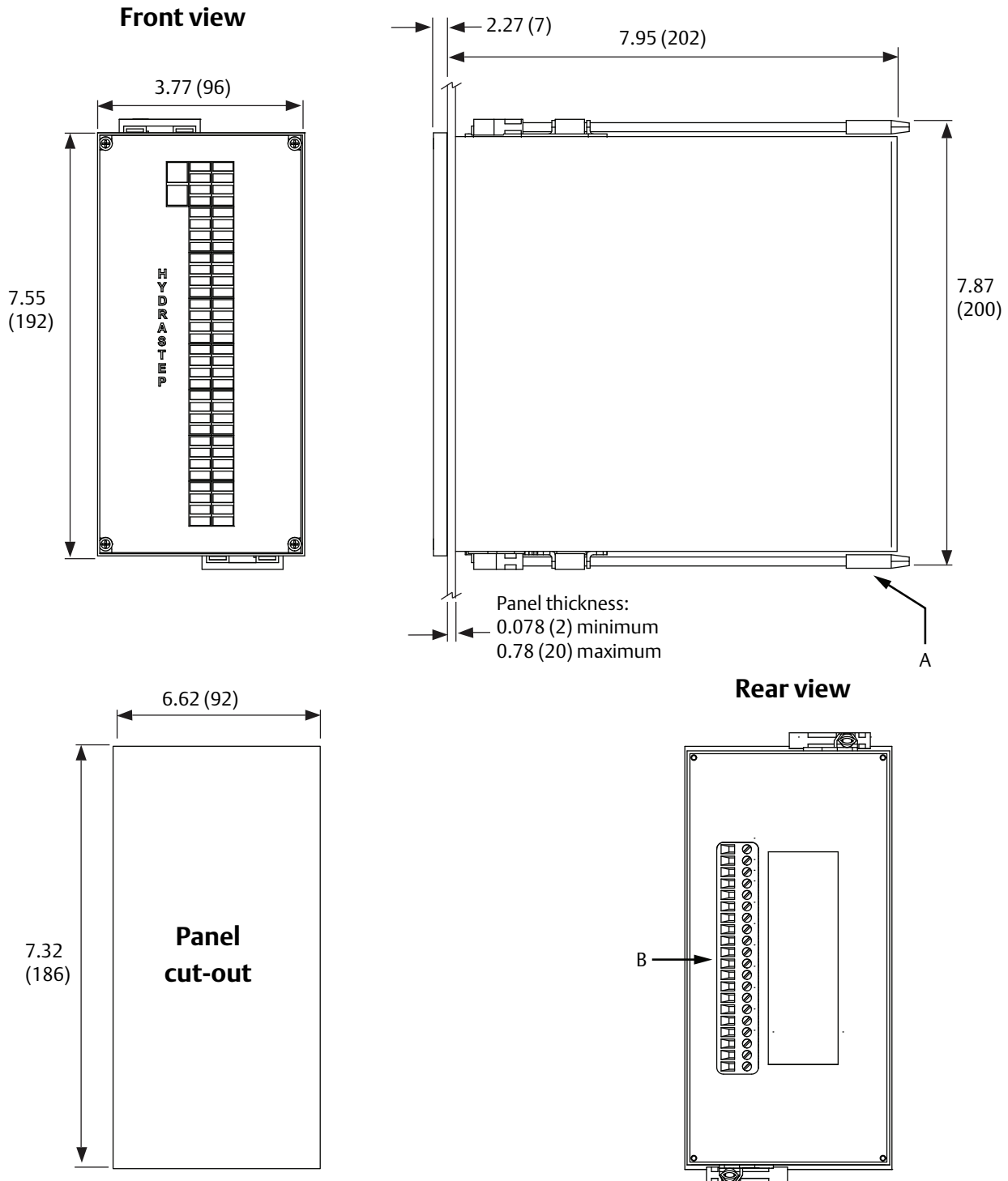

- A. Panel retaining clamps (two positions)
- B. Input terminals

Dimensions are in inches (mm). Allow space at the rear for cabling.

Figure 5. Hydrastep Wall Mount iP65 Remote Display (24683D)

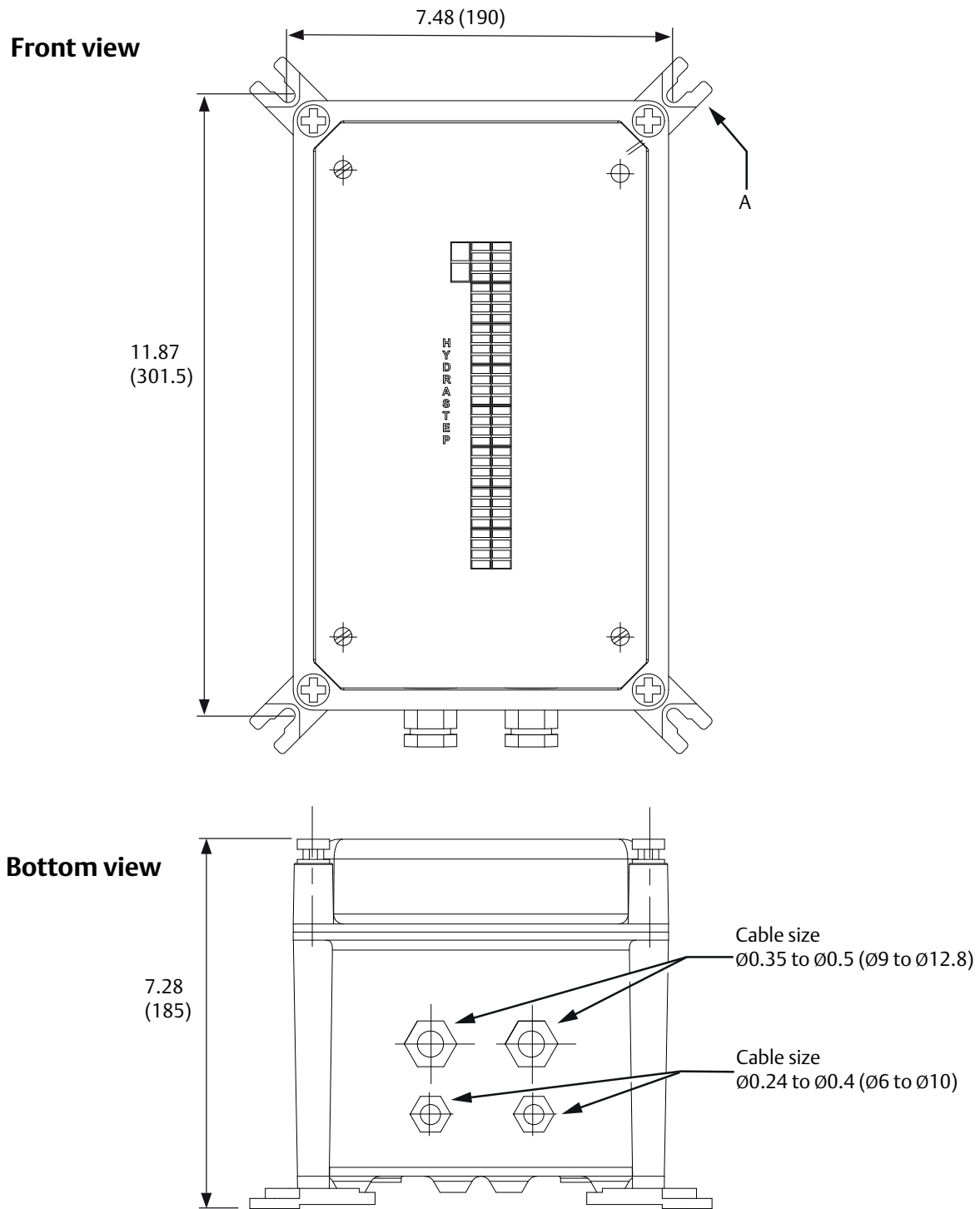

A. Wall mounting points (four positions)

Dimensions are in inches (mm).

Head Office

Emerson Automation Solutions

158 Edinburgh Avenue
Slough, Berks., SL1 4UE, UK

 +44 (0)1753 756600

 +44 (0)1753 823589

 Infocentral@Emerson.com

North America Office

Emerson Automation Solutions

6021 Innovation Blvd.
Shakopee, MN 55379, USA

 +1 800 999 9307 or +1 952 906 8888

 +1 952 949 7001

 RFQ.RMD-RCC@Emerson.com

 [Linkedin.com/company/Emerson-Automation-Solutions](https://www.linkedin.com/company/Emerson-Automation-Solutions)

 [Twitter.com/Rosemount_News](https://twitter.com/Rosemount_News)

 [Facebook.com/Rosemount](https://www.facebook.com/Rosemount)

 [Youtube.com/user/RosemountMeasurement](https://www.youtube.com/user/RosemountMeasurement)

 [Google.com/+RosemountMeasurement](https://www.google.com/+RosemountMeasurement)

Emerson Terms and Conditions of Sale are available upon request
The Emerson logo is a trademark and service mark of Emerson Electric Co
Mobrey and Rosemount are marks of the Emerson family of companies.
All other marks are the property of their respective owners.
© 2018 Emerson. All rights reserved.